



1) Ignition coils connector: located on the right side, above engine, beside frame - pic. (A).

- Remove Red/Black wire from female connector (unlock pin by needle). Place Yellow wire from QS unit to this position (where was Red/Black).
- Remove rubber seal in female connector corner and place Red/Black wire (female-pin) here.
- Remove rubber seal in male connector corner and place Red wire from QS unit.

Check if: a) Red/black wire from MOTORCYCLE is connected to RED from QS unit now.
b) Red/black wire to COILS is connected with YELLOW wire from QS unit now.

1b) Ignition coil connector: this connection is necessary for RPM functions only

Remove Grey/Green wire from main-harness connector (female pin). Place (Blue+Violet) wire from QS unit to this place. Insert female Grey/Green into 1pin connector on Violet wire from QS unit

CONTINUE ON NEXT PAGE

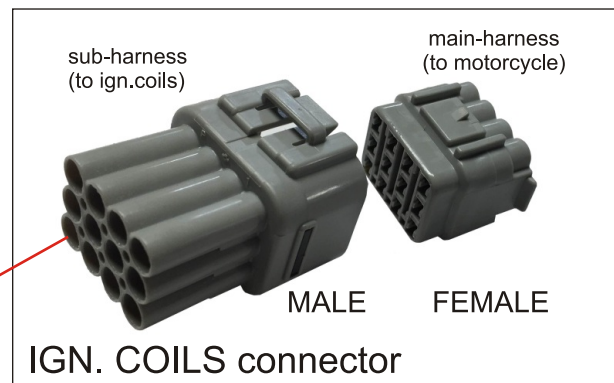
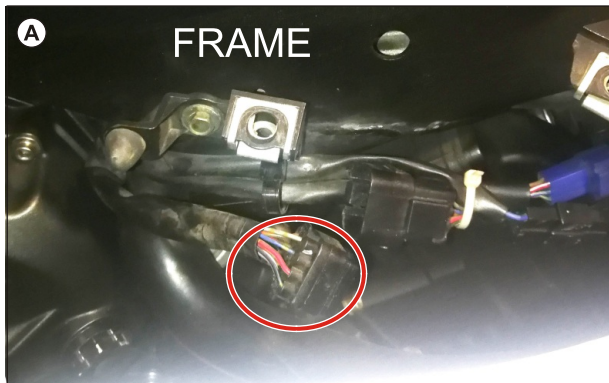

IGNITION COILS

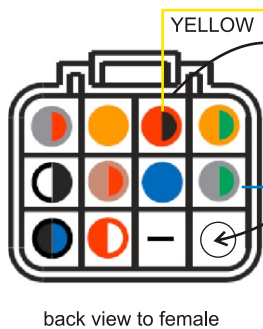
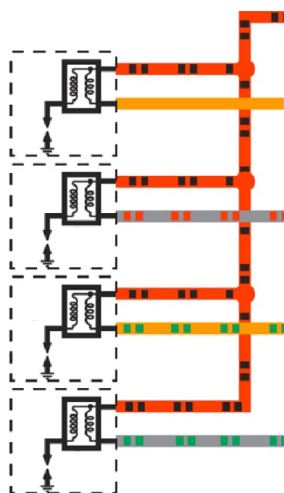

back view to female

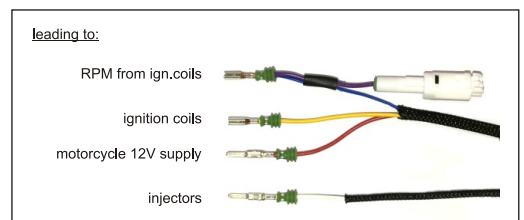

leading to:

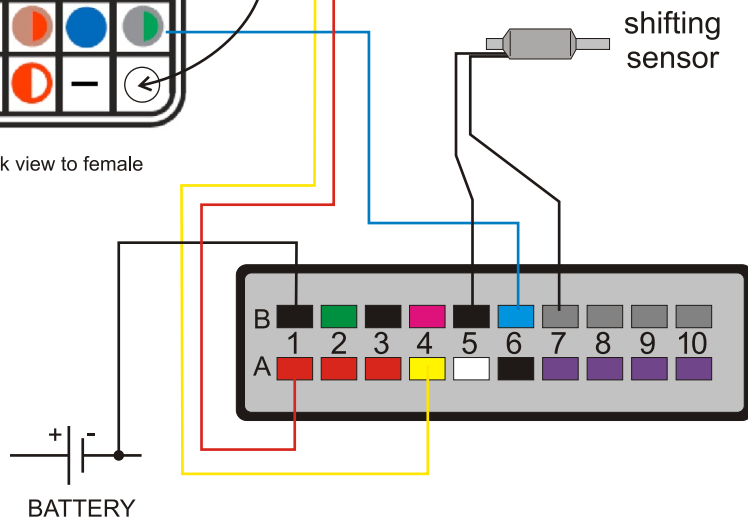
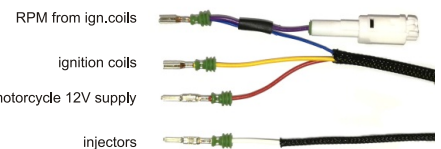

Supplementary Yamaha YZF R1 2006-08



2) **Injectors connector:** located under the fuel tank - pic. (B).

Remove Red/Blue wire from main-harness connector (male pin). Remove rubber seal in same connector and place Red/Blue wire here. Place White wire (male-pin) from QS unit to free position (where was Red/Blue). White wire (male) is going to Red/blue wire (female) leading to injectors now.

3) Connect black wire from QS unit to minus terminal on battery.

4) Connect shifting sensor coupler to QS unit wiring harness - black 2pin

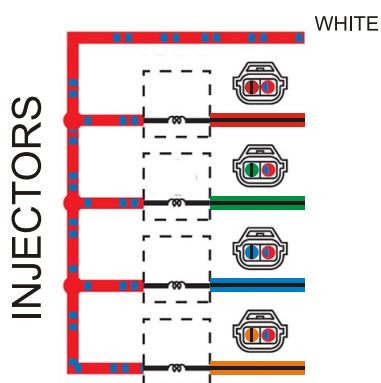

back view to male
(motorcycle side)

